

Mobile Aquatic Stairs Drawings-Signature Block:

I authorise SRS Australia PTY LTD to fabricate the custom Pool Stairs shown on this drawing in accordance with Customer's Purchase Order No. **MAS107**
 I understand and agree that mobile aquatic stairs are unique and are made to the specifications shown on this drawing. SRS Australia PTY LTD warrants only conformance to specification; not installation. ALL OTHER WARRANTIES, INCLUDING THE WARRANTIES OF MERCHANTABILITY AND FITNESS FOR PURPOSE ARE SPECIFICALLY DISCLAIMED.
 DO NOT INSTALL ANCHORS PRIOR TO RECEIVING STAIRS.

Customer Name:..... Authorised Signature:.....

Date:..... Authorised Name(Print):.....

NOTES:

1. Stainless Deck Socket Mounting
2. Step Colour -Light Blue
3. Tread Colour -Safety Yellow
4. Thermoplastic Rail Coating-White

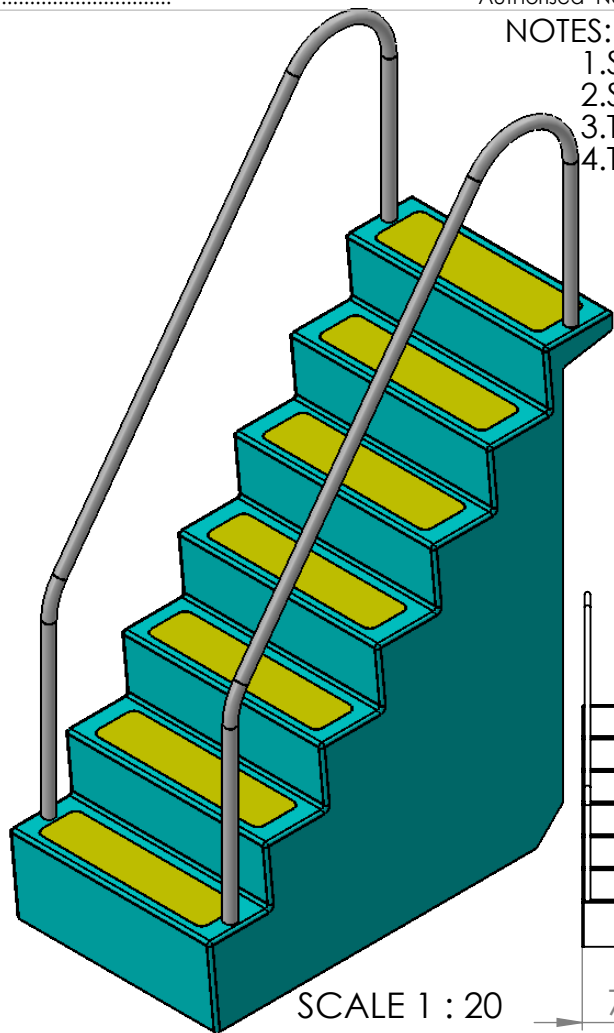

SCALE 1 : 20

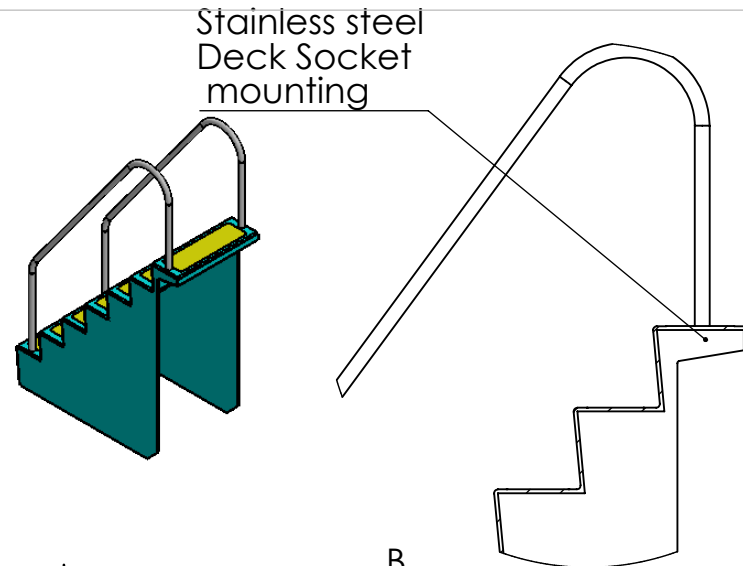
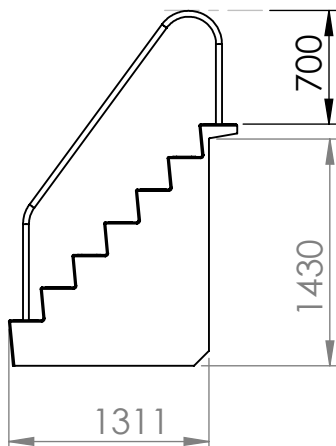
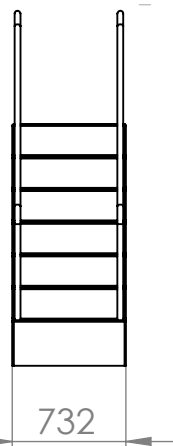
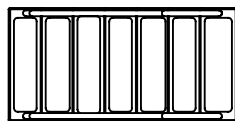

Stainless steel Deck Socket mounting

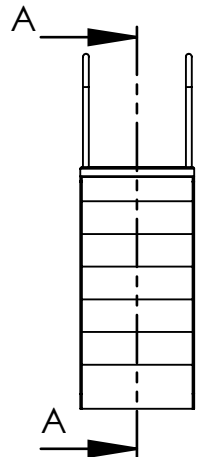

SECTION A-A

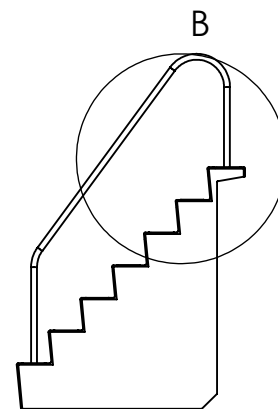

DETAIL B SCALE 1 : 20

PART #: MAS107

DESCRIPTION: R1 STAIRS

UNLESS OTHERWISE SPECIFIED:
 DIMENSIONS ARE IN MILLIMETERS
 SURFACE FINISH:
 TOLERANCES:
 LINEAR: + - 3MIL
 ANGULAR: + - 1

Proprietary and Confidential:
 The information contained in this specification is the sole property of SRS AUSTRALIA PTY LTD. Any reproduction in part or whole without the written consent of SRS AUSTRALIA PTY LTD is prohibited.

DRAWN
 CHK'D
 APPV'D
 MFG

NAME: NA
 SIGNATURE: JS
 DATE: 06.09.18

WEIGHT: 100 KG

MATERIAL: FRP/S.S
 DWG NO.

DO NOT SCALE DRAWING REVISION

© SRS AUSTRALIA PTY LTD

SCALE:

SHEET OF

A4



Serious Equipment - Serious Fun - Access for All
SRS Australia PTY LTD
 12 Enterprise Street, Richlands QLD 4077
 P +61 7 3812 2283 | F +61 7 3812 1187