



IN-POOL FURNITURE

OFFICIAL
POOL
EQUIPMENT
SUPPLIER





IN-POOL FURNITURE

CONTENTS

Overview	3
Destination Series Tables and Seating	4
Destination Series Lounger	8
Destination Series Rocking Lounge Chair ...	10
Resort Series™ Lounger	12
Resort Series Deep Water Lounger	14
Resort Series Rocking Lounge Chair	16
Resort Series Sun Shelf Tables	18

BRING YOUR VACATION HOME

Inspired by the world's most luxurious resorts, S.R.Smith®'s line of professional grade in-pool furniture sets a new standard for style and elegance. The Destination Series and Resort Series products feature table and seating options designed to create spaces for conversation and relaxation.

MINIMUM WEIGHT - MAXIMUM STRENGTH

The Destination Series is manufactured using Resin Transfer Molding (RTM), an advanced manufacturing process used in a diverse range of applications from aerospace to automotive products. The RTM process creates a composite material that has a high strength to weight ratio — although lightweight, it is exceptionally strong and durable. RTM products offer a truly unique look that is salt pool friendly and UV resistant to protect colors from fading.



SALT POOL FRIENDLY









We know pool builders and consumers alike enjoy the benefits of salt chlorinator systems—that's why we've designed a line of products that perform well in salt pool environments. Our Salt Pool Friendly icon is your visual assurance that the most durable and salt friendly materials have been used in manufacturing.



Destination Series New Construction Tables and Seating

Make the most of a sun shelf with tables and seating that allow you to cool off without splashing around. Bring your book, your favorite beverage and a snack to spend hours relaxing in your personal destination space.

- Tables & seats designated for 6-inch anchors
- Pole height can be customized in the field (suggest using a hacksaw with a new blade)
- Easy to insert and remove without tools
- Salt pool friendly
- Tables with or without cupholders
- Available in assorted colors and visual textures

							
16" Pool Seat includes 42" pole	16" Table and Umbrella Support	30" Pool or Spa Table with Umbrella Support	30" Pool or Spa Table with Cup Holders and Umbrella Support	54" Pole may be cut to custom length	18" Pole	Gunite 6" Bronze Anchor	Vinyl Liner 6" Plastic Anchor
Mounts to pole and secured in bronze anchor				For tall tables in pools or spas	For sun shelves	Supports pole for tables and seats	

Destination Series Retrofit Table Kits

Upgrade an ordinary sun shelf to an extraordinary conversation space or relaxation station with Retrofit Sun Shelf Table Kits. Kits include everything you need to upgrade your shade with an easy-to-install adapter that enables you to retrofit your existing umbrella sleeve with professional-grade in-pool furniture.

				
16" Table with Umbrella Support	30" Pool or Spa Table and Umbrella Support	30" Pool or Spa Table with Cup Holders and Umbrella Support	18" Pole	Umbrella Sleeve Adapter
			For sun shelves	7.5" adapter pole fits existing umbrella sleeve

COLOR OPTIONS

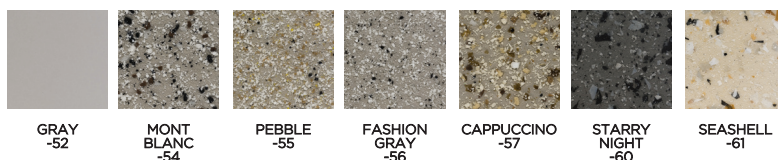



POOL TABLES

Part No.	Description
WS-16 TABLE-XX	16" Table with Umbrella Hole
WS-POOLTABLE-XX	30" Table with Umbrella Hole
WS-POOLTABLE-CH-XX	30" Table with Umbrella Hole and Cup Holders

POOL SEATING

Part No.	Description
WS-POOLSEAT-XX	16" Pool Seat

POLES

Part No.	Description
WS-18POLE-NOANC	18" Pool/Spa Table Pole No Anchor
WS-PSPOLE-NOANC	42" Pool Seating Pole Only - Anchor Not Included
WS-PTPOLE-NOANC	54" Pool Table Pole Only - Anchor Not Included

ANCHORS

Part No.	Description
WS-POOL-ANCHOR	6" Gunite Bronze Anchor with Cap
VL-ANCHOR-1.90	6" Vinyl Liner Anchor with Cap

MINIMUM CONCRETE
POUR DIMENSIONS

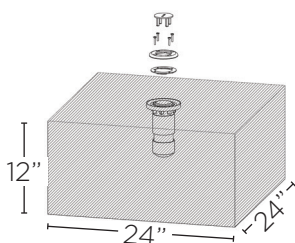

ANCHOR FOR GUNITE POOLS

Tables and seats
install in pools w/6"
bronze anchor
WS-POOL-ANCHOR



ANCHOR FOR VINYL POOL LINER

Tables and seats install
in vinyl liner pools
VL-ANCHOR 1.90



RETROFIT SUN SHELF TABLE KITS

Select the 16- or 30-inch table you want to add to your sun shelf and your kit will come complete with everything you need to retrofit your existing umbrella sleeve. You can upgrade your shade in three easy steps!

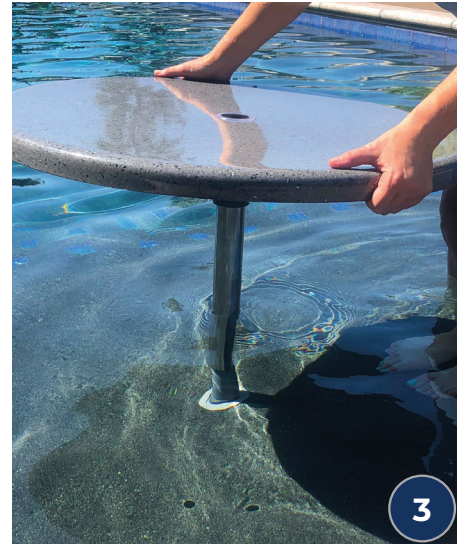

*Adapter designed for 7 1/4" anchor sleeves; may be cut down to side for shorter umbrella anchor sleeves.

- 1 - Place adapter into existing anchor*
- 2 - Slide support pole into the table
- 3 - Place table and pole onto adapter and insert umbrella

ADAPTER KIT

Part No.	Description
PL-ADAPTER-1.50	Adapter Kit for Sun Shelf Table

Destination Series sun shelf tables install into most 1.5-inch umbrella anchors in three easy steps with the Adapter Kit from S.R.Smith. Adapter Kits have been verified for use with most popular 6-inch umbrella anchor manufacturers including Aqua Star®, Waterway™ and CMP®. Compatibility with other brands is not guaranteed.



Destination Series Lounger

The Destination Lounger lets you relax and enjoy the pool without a splash. Elegant design and sturdy construction combine to give pool owners the opportunity to upgrade their sun shelf space with ease. The innovative design allows pool owners to easily fill the base section with water but, more importantly, allows them to move the lounger to remove water so it's easy to take it off the sun shelf when not in use.

- Easy to drain and remove when not in use
- Perfect for residential or commercial use
- For use on a pool ledge with water depths up to 12 inches
- High-quality RTM composite material
- UV protection to resist fading
- Compatible with all pool types, including vinyl
- Exclusive colors and visual textures





Shown in Cappuccino



Part No.	Description
SHIPPING: 35 lbs - 68"L x 22"W x 17.22"H CLASS 70 16 kg - 173cm x 56cm x 44cm	
DS-1-52	Destination Lounger - Solid Gray
DS-1-54	Destination Lounger - Mont Blanc
DS-1-55	Destination Lounger - Pebble
DS-1-56	Destination Lounger - Fashion Gray
DS-1-57	Destination Lounger - Cappuccino
DS-1-60	Destination Lounger - Starry Night
DS-1-61	Destination Lounger - Seashell

COLOR OPTIONS



DESTINATION SERIES LOUNGER DIMENSIONS

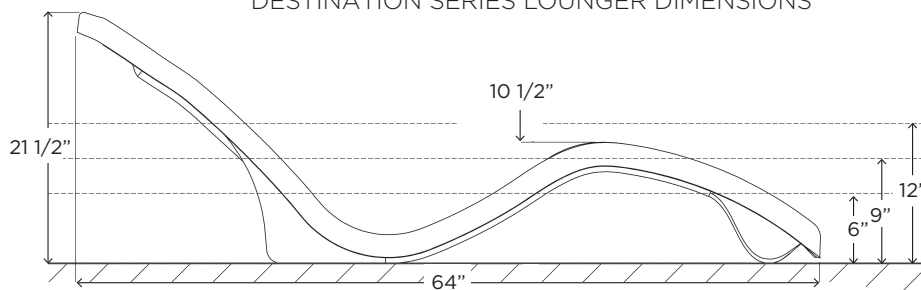

WEIGHT OF EMPTY CHAIR = 25 LBS

WEIGHT OF LOUNGER IN WATER
 6" DEPTH = 56 LBS
 9" DEPTH = 66 LBS
 12" DEPTH = 71 LBS

Destination Series Rocking Lounge Chair

The Destination Series Rocking Lounge Chair is the latest addition to the S.R.Smith® In-Pool Furniture line. This elegantly designed and sturdy model offers a slight rocking feature that allows for easier exit off the chair while in the pool. The innovative design allows the Rocking Lounge Chair to be quickly drained allowing it to be removed from the sun shelf when not in use.

- For use on pool shelves with water depths up to 12 inches
- Easy to drain and remove when not in use
- Perfect for residential or commercial use
- Offers slight rocking feature for easier exit off chair
- High-quality RTM composite design
- UV protected to resist fading
- Compatible with all pool types
- Exclusive colors and visual textures





Shown in Seashell



Part No.	Description
----------	-------------

SHIPPING: 20 lbs - 54"L x 22"W x 19"H | CLASS 70
9 kg - 137cm x 56cm x 74cm

DS-2-52	Rocking Lounge Chair - Gray
DS-2-54	Rocking Lounge Chair - Mont Blanc
DS-2-55	Rocking Lounge Chair - Pebble
DS-2-56	Rocking Lounge Chair - Fashion Gray
DS-2-57	Rocking Lounge Chair - Cappuccino
DS-2-60	Rocking Lounge Chair - Starry Night
DS-2-61	Rocking Lounge Chair - Seashell

COLOR OPTIONS



DESTINATION SERIES ROCKING LOUNGE CHAIR DIMENSIONS

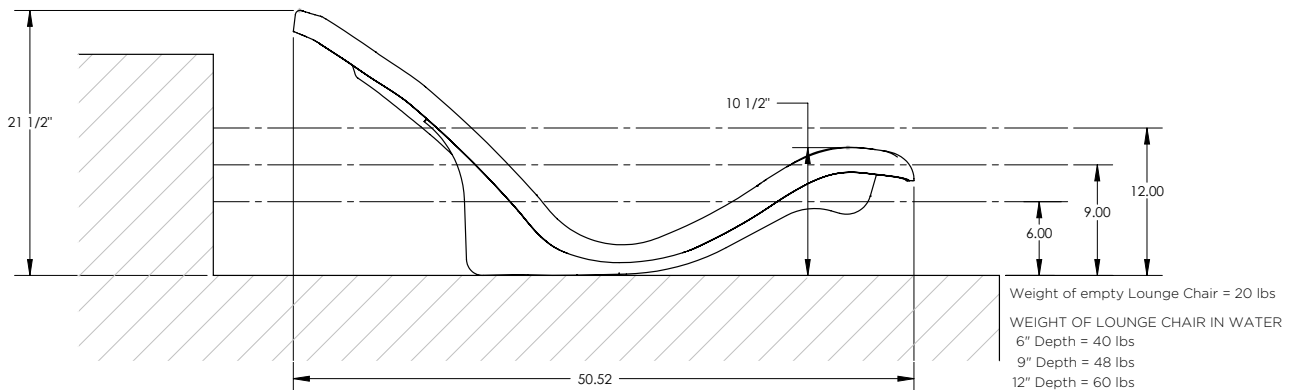

Resort Series™ Lounger

It's never been easier to add in-pool loungers. Position these lightweight Resort Series Loungers on your sun shelf, then simply press down as they fill themselves with water in seconds—no tools, tanks or hoses required.

- Proprietary self-filling technology allows for easy installation and removal—no tools or hoses needed
- Ideal for use in water up to 12-inches deep
- Durable rotomolded construction for long-lasting use with built-in UV protection that resists fading
- Add seating to any pool with a sun shelf
- Available in five colors and visual textures to complement any poolscape
- Pair loungers with Resort Series Sun Shelf Tables to complete your retreat





Shown in White

Part No.	Description
SHIPPING: 32 lbs - 68"L x 22"W x 17.22"H CLASS 70 16 kg - 172cm x 56cm x 44cm	
RS-1-2	Resort Series Lounger - White
RS-1-10	Resort Series Lounger - Taupe
RS-1-20	Resort Series Lounger - Gray
RS-1-23	Resort Series Lounger - Sandstone
RS-1-24	Resort Series Lounger - Gray Granite

COLOR OPTIONS

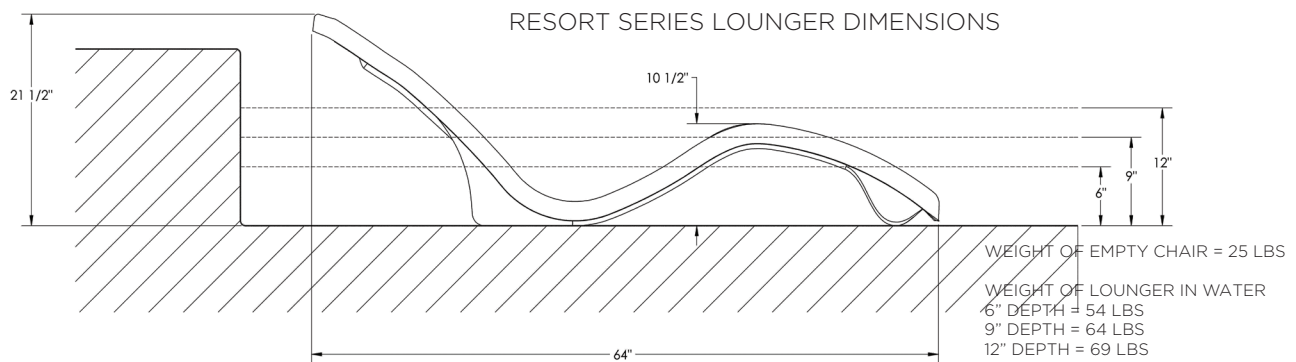
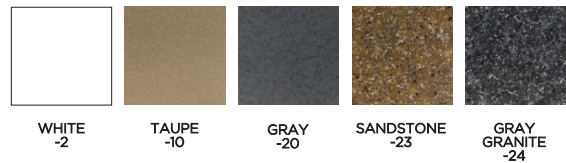

Resort Series™ Deep Water Lounger

Sit back and relax comfortably in water up to 15-inches deep. The Resort Series Deep Water Loungers stay put on sun shelves with a bit more depth using our proprietary self-filling technology that makes installation easy.

- A bigger base holds more water to keep your lounger securely situated in deeper water
- Proprietary self-filling technology allows for easy installation and removal—no tools or hoses needed
- Higher base makes it easier to sit down and stand up
- Durable rotomolded construction for long-lasting use with built-in UV protection that resists fading
- Add seating to any pool with a sun shelf up to 15-inches deep
- Available in five colors and visual textures to complement any poolscape
- Pair Deep Water Loungers with Resort Series 18-inch Sun Shelf Tables to complete your retreat





Shown in White

Part No.	Description
SHIPPING: 42 lbs - 68"L x 23"W x 26"H 15 kg - 173cm x 58cm x 66cm	
RS-3-2	Resort Series Deep Water Lounger - White
RS-3-10	Resort Series Deep Water Lounger - Taupe
RS-3-20	Resort Series Deep Water Lounger - Gray
RS-3-23	Resort Series Deep Water Lounger - Sandstone
RS-3-24	Resort Series Deep Water Lounger - Gray Granite

COLOR OPTIONS

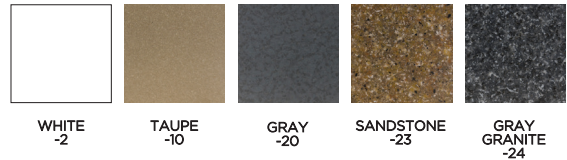

WHITE
-2

TAUPE
-10

GRAY
-20

SANDSTONE
-23

GRAY
GRANITE
-24

RESORT SERIES DEEP WATER LOUNGER DIMENSIONS

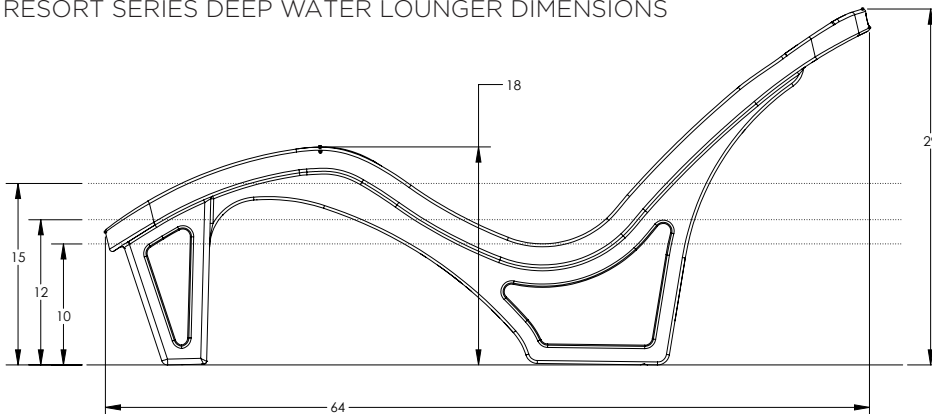

WEIGHT OF EMPTY CHAIR = 28 LBS

WEIGHT OF LOUNGER IN WATER
10" DEPTH = 110 LBS
12" DEPTH = 140 LBS
15" DEPTH = 184 LBS

Resort Series™ Rocking Lounge Chair

Sit back, relax and enjoy your pool with Resort Series Rocking Loungers. Featuring an upright design, slight rocking motion and our self-filling technology that makes installation simple as 1-2-3, you'll be sitting pretty in no time.

- A slight rocking motion makes it easier to stand back up
- The unique reclining angle allows you to sit up straighter while relaxing
- Proprietary self-filling technology allows for easy installation and removal—no tools or hoses needed
- Durable rotomolded construction for long-lasting use with built-in UV protection that resists fading
- Add seating to any pool with a sun shelf
- Available in five colors and visual textures to complement any poolscape
- Pair Rocking Loungers with Resort Series Sun Shelf Tables to complete your retreat





Shown in White

Part No.	Description
SHIPPING: 28 lbs - 53"L x 23"W x 19.5"H 9 kg - 135cm x 58cm x 50cm	
RS-2-2	Resort Series Rocking Lounge Chair - White
RS-2-10	Resort Series Rocking Lounge Chair - Taupe
RS-2-20	Resort Series Rocking Lounge Chair - Gray
RS-2-23	Resort Series Rocking Lounge Chair - Sandstone
RS-2-24	Resort Series Rocking Lounge Chair - Gray Granite

COLOR OPTIONS

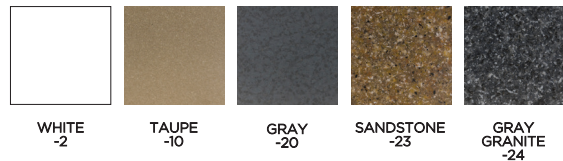

RESORT SERIES ROCKING LOUNGE CHAIR DIMENSIONS

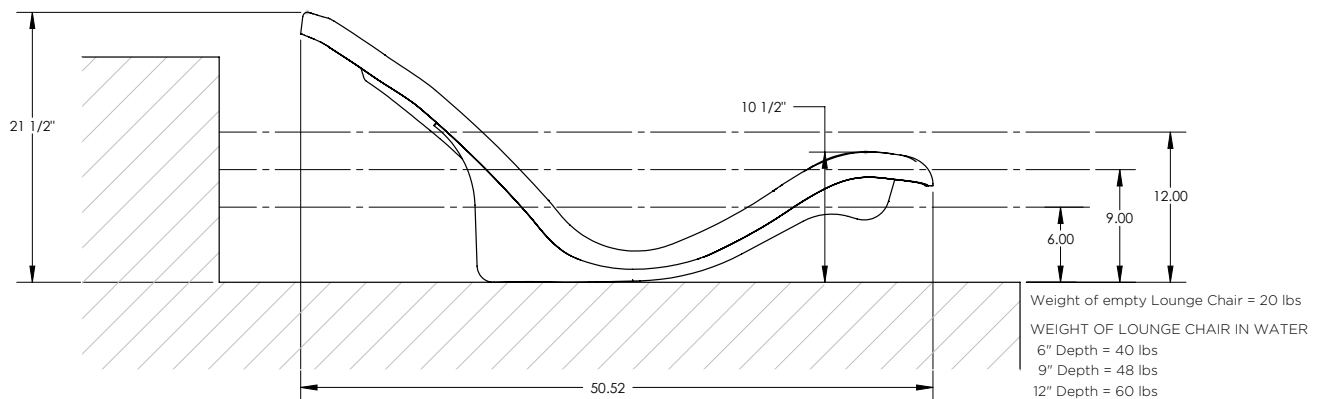

Resort Series™ Sun Shelf Tables

The perfect spot to rest a book or a beverage, Resort Series Sun Shelf Tables are lightweight and easy to use. Simply place the table where you want and press firmly—our self-filling technology ensures it stays put.

- Proprietary self-filling technology allows for easy installation and removal—no tools or hoses needed
- Made to accommodate a standard pool umbrella for relaxing in the shade
- Keep everything you need high, dry and nearby
- Durable rotomolded construction for long-lasting use with built-in UV protection that resists fading
- Add Resort Series Sun Shelf Tables to any pool with a sun shelf or beach entry
- Available in five colors and visual textures to complement any poolscape
- Pair with in-pool loungers to complete your retreat





Shown in White

Part No.	Description
SHIPPING: 15.5 lbs - 25"L x 25"W x 19"H 7 kg - 64cm x 54cm x 48cm	
RS-4-2	Resort Series 15" Sun Shelf Table - White
RS-4-10	Resort Series 15" Sun Shelf Table - Taupe
RS-4-20	Resort Series 15" Sun Shelf Table - Gray
RS-4-23	Resort Series 15" Sun Shelf Table - Sandstone
RS-4-24	Resort Series 15" Sun Shelf Table - Gray Granite
SHIPPING: 16 lbs - 25"L x 25"W x 19"H 7 kg - 64cm x 54cm x 48cm	
RS-5-2	Resort Series 18" Sun Shelf Table - White
RS-5-10	Resort Series 18" Sun Shelf Table - Taupe
RS-5-20	Resort Series 18" Sun Shelf Table - Gray
RS-5-23	Resort Series 18" Sun Shelf Table - Sandstone
RS-5-24	Resort Series 18" Sun Shelf Table - Gray Granite

COLOR OPTIONS

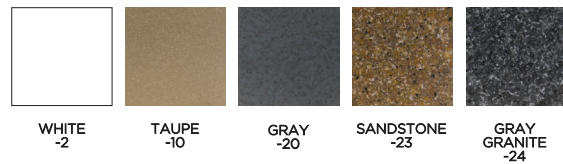

RESORT SERIES SUN SHELF TABLE DIMENSIONS

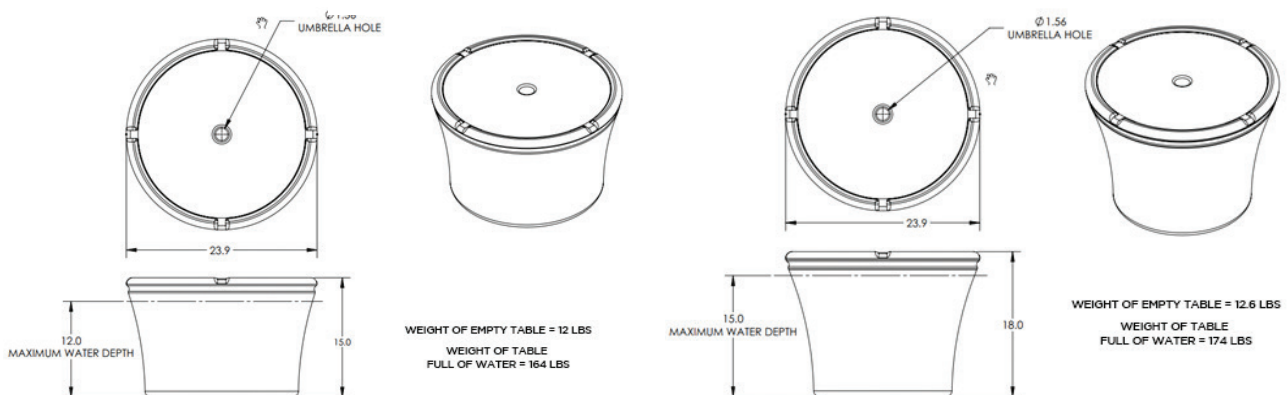



Pool **Better**[™]

A Fluidra Brand | SRSmith.com | 1.800.822.7933

©2024 Fluidra. All rights reserved. The trademarks and trade names used herein are the property of their respective owners. 98853_SL

